



Ford Custom 2018-

Art. 807305

Euroraud | EU Eurobar | EC form | EU Eurobar



- | | |
|-------------------------------------------------------------------------|----|
| 1. Euroraud / EU Eurobar / EC form / EU Eurobar | 1 |
| 2. Kronstein / bracket / wspornik / Konsole | 2 |
| 3. Kronstein / bracket / wspornik / Konsole | 2 |
| 4. Kronstein / bracket / wspornik / Konsole | 1 |
| 5. Kronstein / bracket / wspornik / Konsole | 1 |
| 6. Kronstein / bracket / wspornik / Konsole | 1 |
| 7. Kronstein / bracket / wspornik / Konsole | 1 |
| 8. Kronstein / bracket / wspornik / Konsole | 2 |
| 9. Polt / bolt / śruba / Bolzen M6x20 | 2 |
| 10. Polt / bolt / śruba / Bolzen M8x20 | 2 |
| 11. Polt / bolt / śruba / Bolzen M8x30 | 4 |
| 12. Polt / bolt / śruba / Bolzen M10x25 | 8 |
| 13. Seib / washer / podkładka / Scheibe 6,4x18x1,6 | 2 |
| 14. Seib / washer / podkładka / Scheibe 8,4x16x1,6 | 2 |
| 15. Seib / washer / podkładka / Scheibe 8,4x24x2 | 6 |
| 16. Seib / washer / podkładka / Scheibe 10,5x20x2 | 14 |
| 17. Mutter / nut / nakrętka / Mutter M8 | 2 |
| 18. Mutter / nut / nakrętka / Mutter M10 DIN934 | 2 |
| 19. Mutter / nut / nakrętka / Mutter M10 DIN985 | 4 |
| 20. Vedruseib / spring washer / podkładka sprężysta / Federnscheibe A6 | 2 |
| 21. Vedruseib / spring washer / podkładka sprężysta / Federnscheibe A8 | 4 |
| 22. Vedruseib / spring washer / podkładka sprężysta / Federnscheibe A10 | 4 |

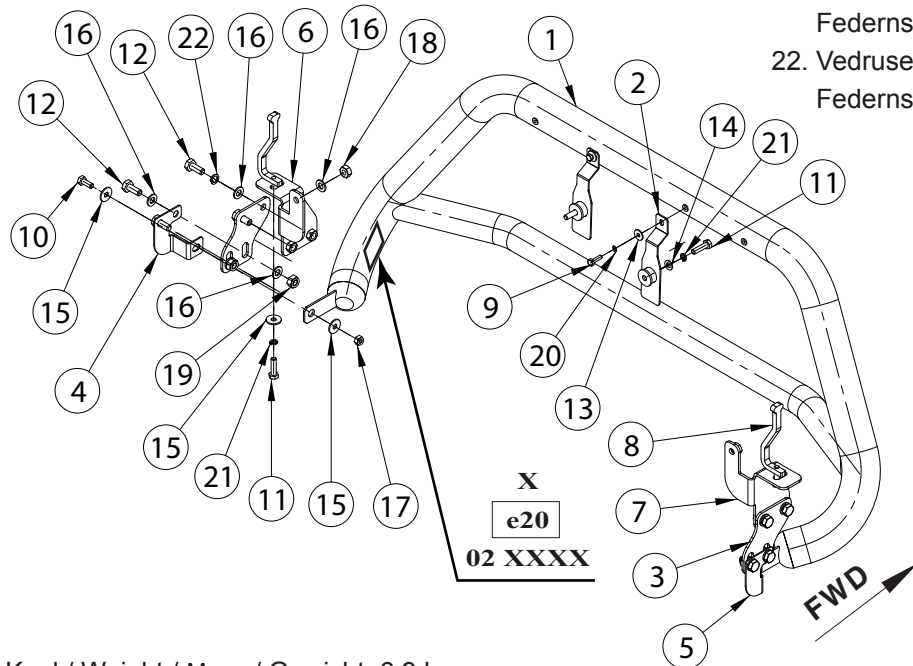

M8 - 25 Nm
M10 - 50 Nm

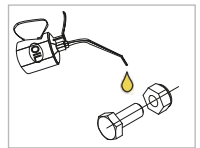

Kaal / Weight / Masa / Gewicht: 6,9 kg

Paigaldusaeg / Time of mounting / Czas montażu / Einbauzeit: 60 min

Vajalikud tööriistad / Required Tools / Wymagane narzędzia / Benötigte Werkzeuge

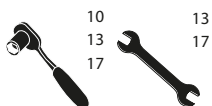

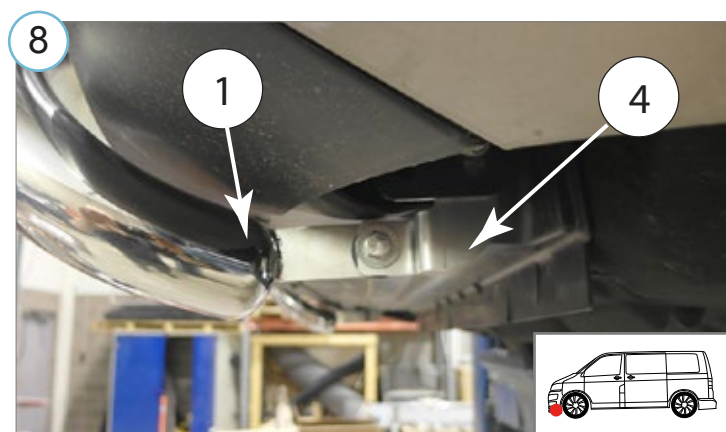
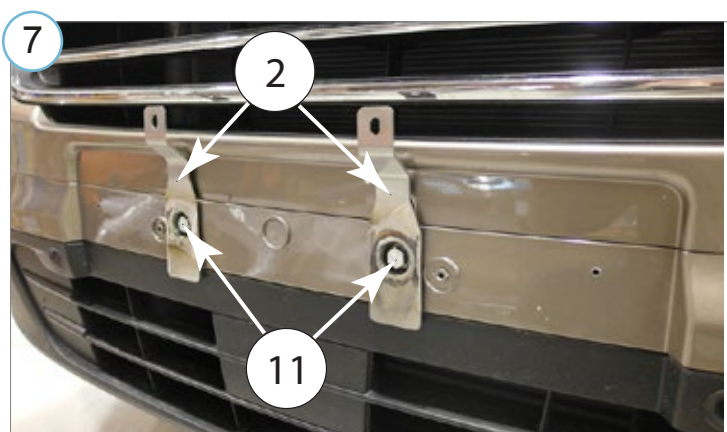
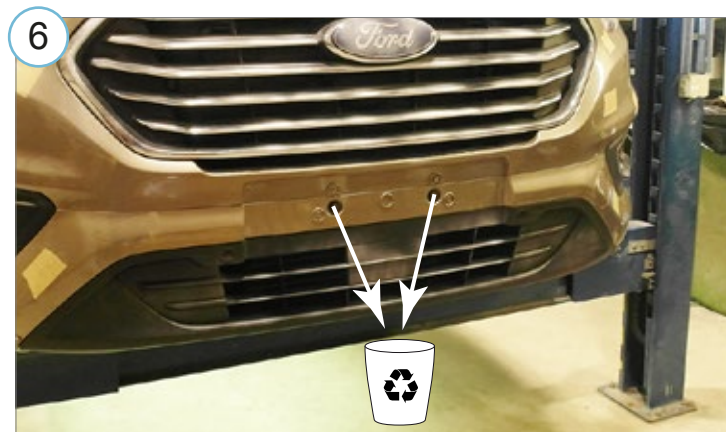
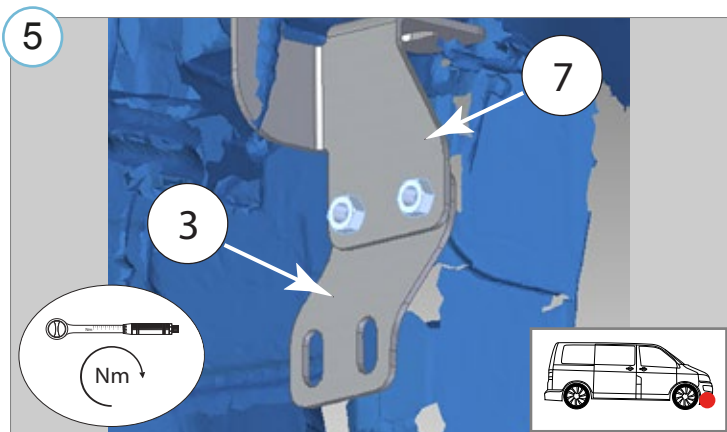
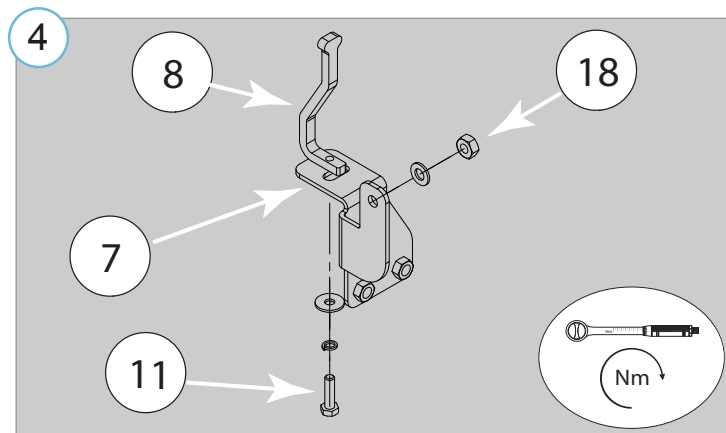
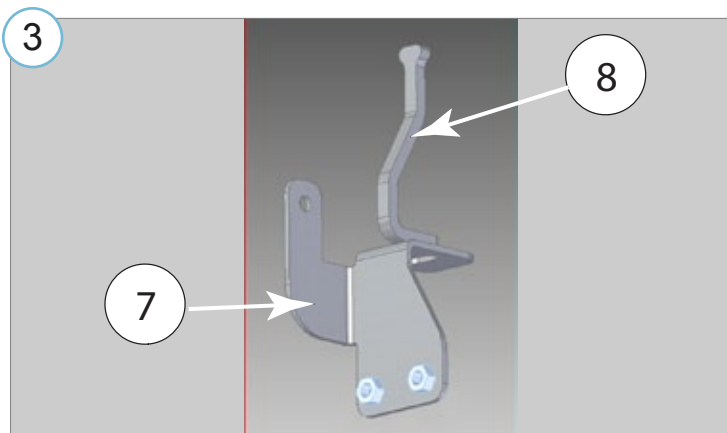
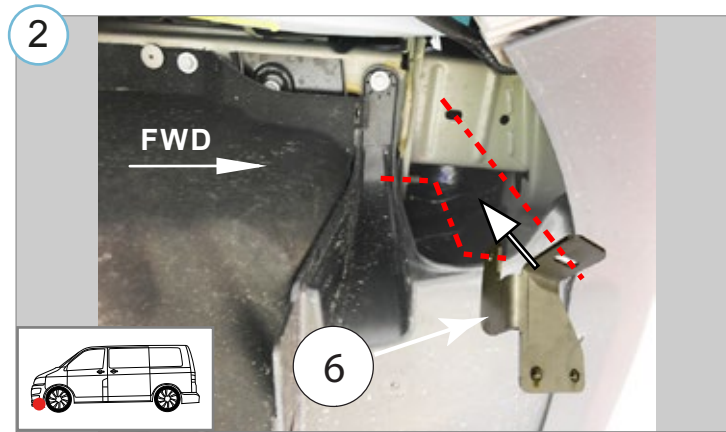
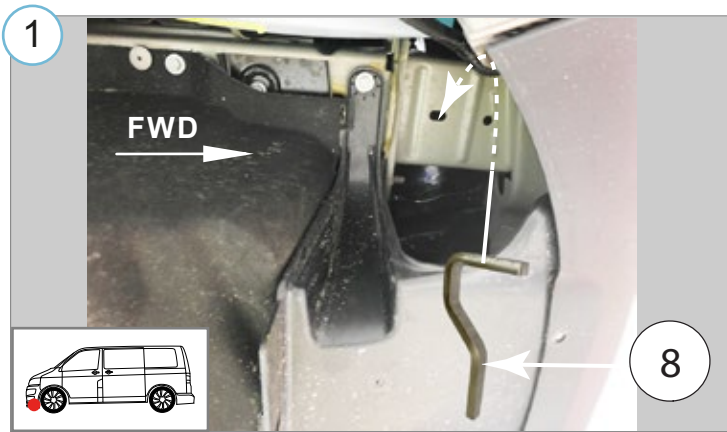

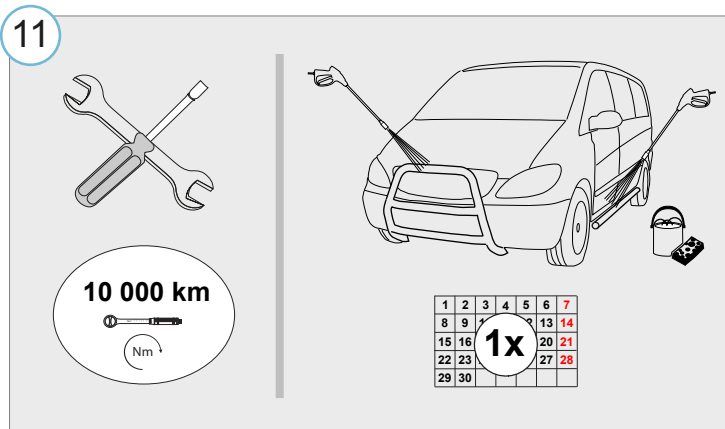
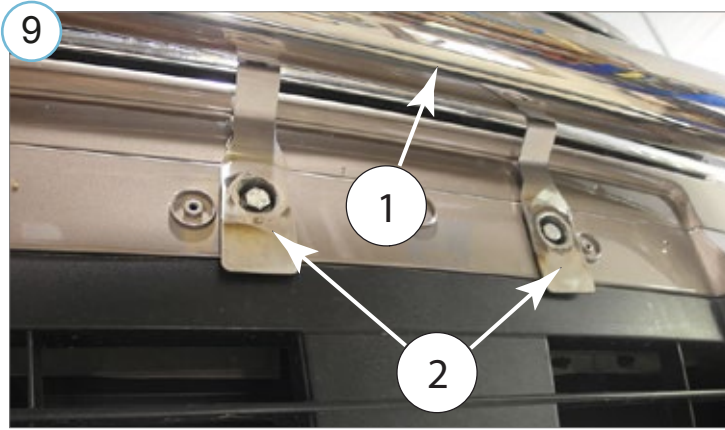

- Kui METEC toode ei vasta Teie ootustele või kui on tegemist toote ebapiisava kvaliteediga, siis pretensioonid esitada lehel www.metec.ee
- If the METEC product does not meet Your expectations or if it is a product of insufficient quality, then you can submit a claim at www.metec.ee
- Jeśli produkt nie spełnia Twoich oczekiwań Meteci, lub jeśli są niewystarczającej jakości, następnie przedstawić roszczeń do www.metec.ee strona
- Wenn METEC Produkt nicht Ihren Erwartungen entspricht oder wenn es um Qualitätsmängel geht, dann bitte die Ansprüche auf Seite www.metec.ee

Lisa /extra / dodatek / Extra 1

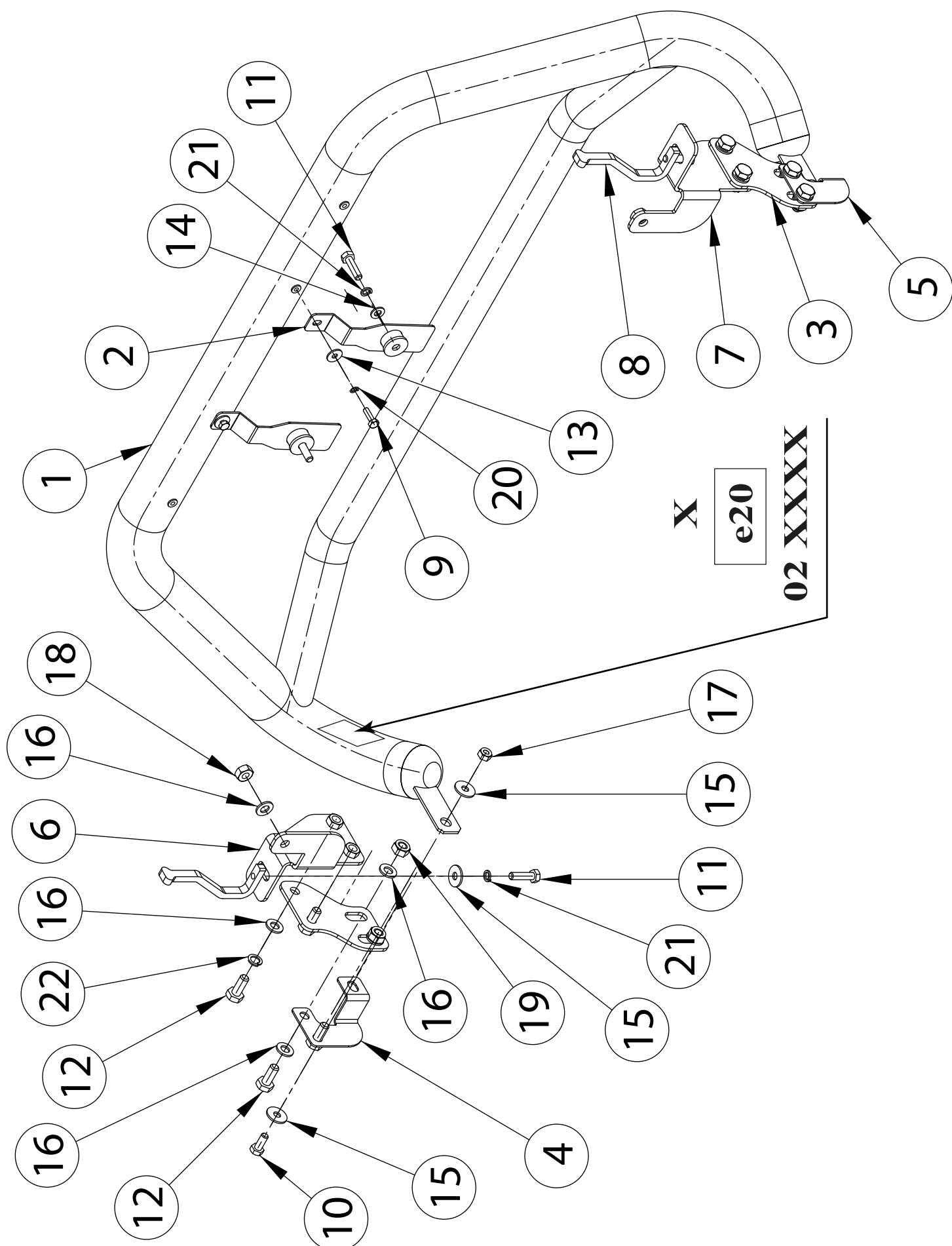

Lisa /extra / dodatek / Extra 2

